

BT-8500

Snelstartgids

07-2020 / v1.0

Edimax Technology Co., Ltd.

No. 278, Xinhu 1st Rd., Neihu Dist., Taipei City, Taiwan

Email: support@edimax.com.tw

Edimax Technology Europe B.V.

Fijenhof 2, 5652 AE Eindhoven, The Netherlands

Email: support@edimax.nl

Edimax Computer Company

3444 De La Cruz Blvd., Santa Clara, CA 95054, USA

Email: support@edimax.com

Inhoud

I. Productinformatie en Veiligheidsinstructies	1
I-1. Inhoud van de verpakking	2
I-2. Systeemvereisten.....	2
I-3. Hardware interface	2
II. Hardware-installatie	3
III. Installatie van stuurprogramma.....	4
IV. Apparaten toevoegen.....	6
V. Een driver verwijderen	9

I. Productinformatie en Veiligheidsinstructies

De Edimax BT-8500 dual mode (BR/EDR + LE) real bluetooth 5.0 is een nano USB-adapter die datasnelheden van maximaal 3 Mbps.

De BT-8500 is een draagbare ultrakleine USB-adapter met USB 2.0. U kunt de adapter in een USB-poort plaatsen en direct profiteren van het supersnelle Bluetooth 5.0.

Installeer eerst de unit met de veiligheidsbeperkingen hieronder beschreven:

- Plaats de draadloze adapter niet in of nabij vochtige omgevingen, zoals in de keuken of badkamer.
- Er bevinden zich geen onderdelen die door gebruikers onderhouden moeten worden in de draadloze adapter. Als u problemen ondervindt met de draadloze adapter, neem dan contact op met de winkel waar u het product gekocht hebt.
- De USB-adapter is een elektrisch apparaat, als het om welke reden dan ook nat wordt, stop dan onmiddellijk het gebruik.

U kunt alle ondersteunde documentatie vinden via de onderstaande link of QR code:

<https://www.edimax.com/download>



(Als u op de officiële Edimax website bent, voer dan het modelnr. "BT -8500" in op de zoekbalk om uw product te vinden.)

Download

To select your product and find related download materials, enter the model number into the search box on the right side or follow the simple steps below:
*Feel free to contact us anytime if you need help or if you can't find your product.

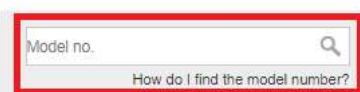

I-1. Inhoud van de verpakking



BT8500 USB-adapter



Snelstartgids

I-2. Systemvereisten

- Windows 8.1/10 32bit/64bit of daarboven
- Linux: kernel 2.6.32~4.15, aanbevolen 4.4 (later)
- 1 x USB 2.0 Type A

I-3. Hardware interface

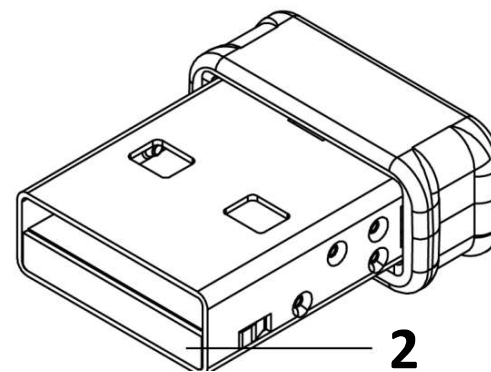
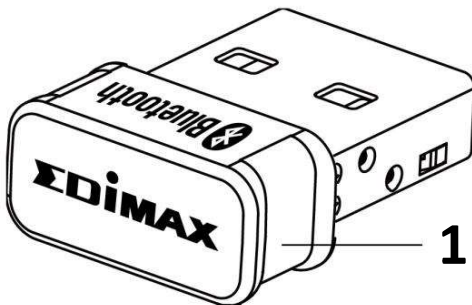

Nr.	Beschrijving
1	Behuizing
2	USB 2.0 - Type A

II. Hardware-installatie

Volg de onderstaande instructies om de USB-adapter te installeren,

1. Schakel uw PC in.

 **Als uw PC of laptop Bluetooth heeft, schakel dan eerst Bluetooth uit voordat u de Bluetooth USB-adapter in gebruik neemt.**

2. Sluit de USB flash aan op een beschikbare USB-poort van uw computer.

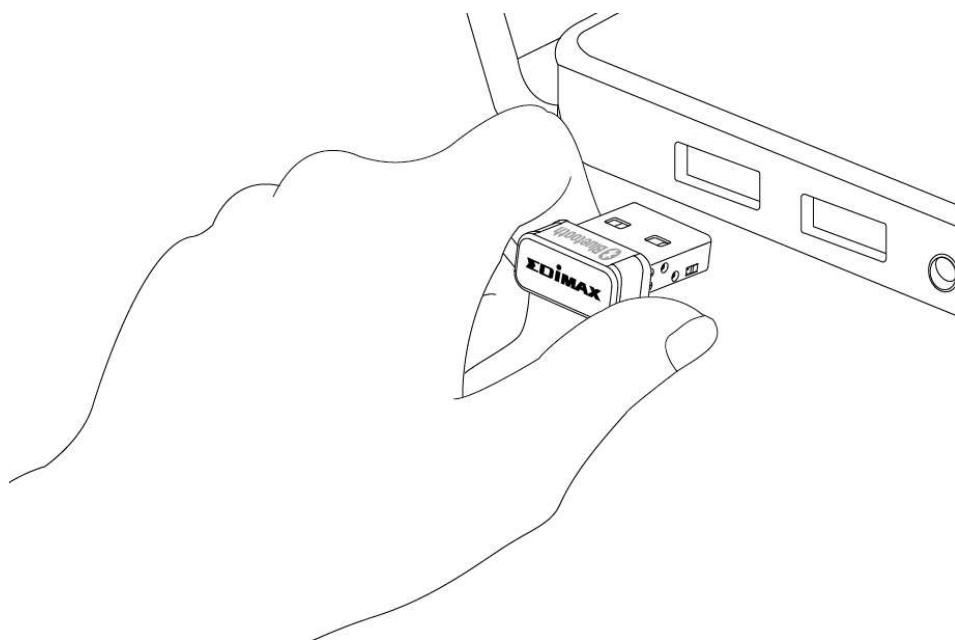

 **Gebruik nooit kracht om de USB-adapter te plaatsen.**

III. Installatie van stuurprogramma

Volg alstublieft de volgende stappen om de driver te installeren,

1. Ga naar de Edimax website (<https://www.edimax.com/edimax/global/>).
2. Voer model nr. "BT-8500" in op de zoekbalk om te zoeken naar uw product en ga naar downloads om de driver te downloaden.

Download

To select your product and find related download materials, enter the model number into the search box on the right side or follow the simple steps below:
*Feel free to contact us anytime if you need help or if you can't find your product.

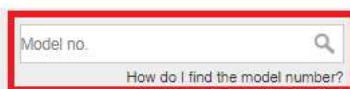

Model no.

[How do I find the model number?](#)

3. Open de map en dubbelklik  setup.exe om de driver te installeren.

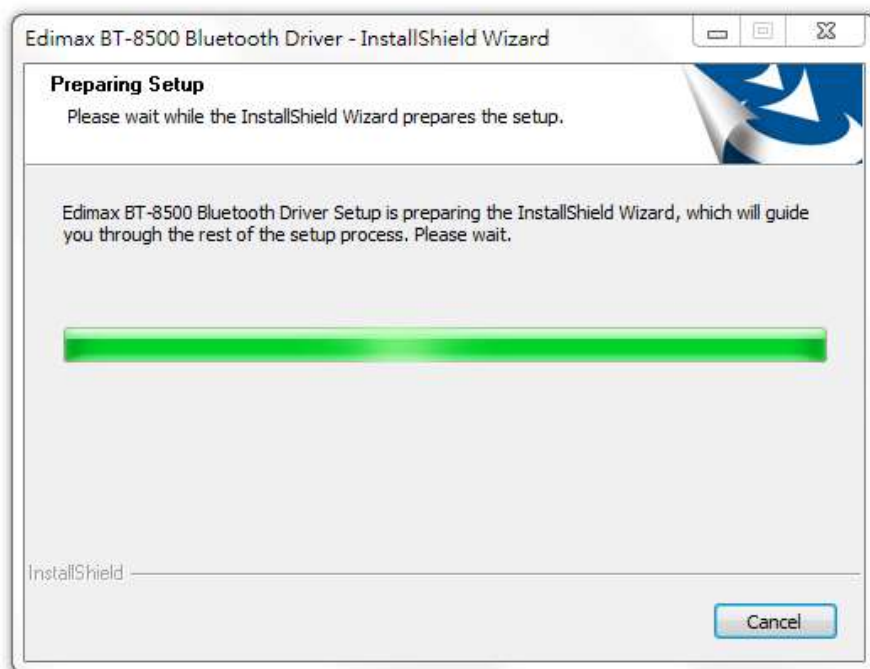

4. Ga verder door op "Volgende" te klikken en volg de instructies op het scherm tot de installatie is voltooid.

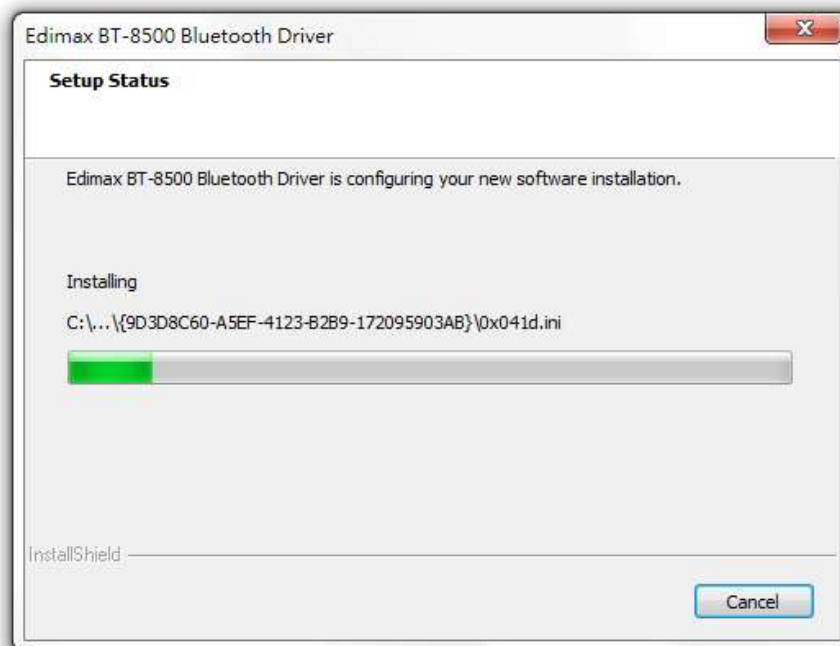

5. Kies of u uw computer nu of op een later moment wilt herstarten en klik op "Voltooien".

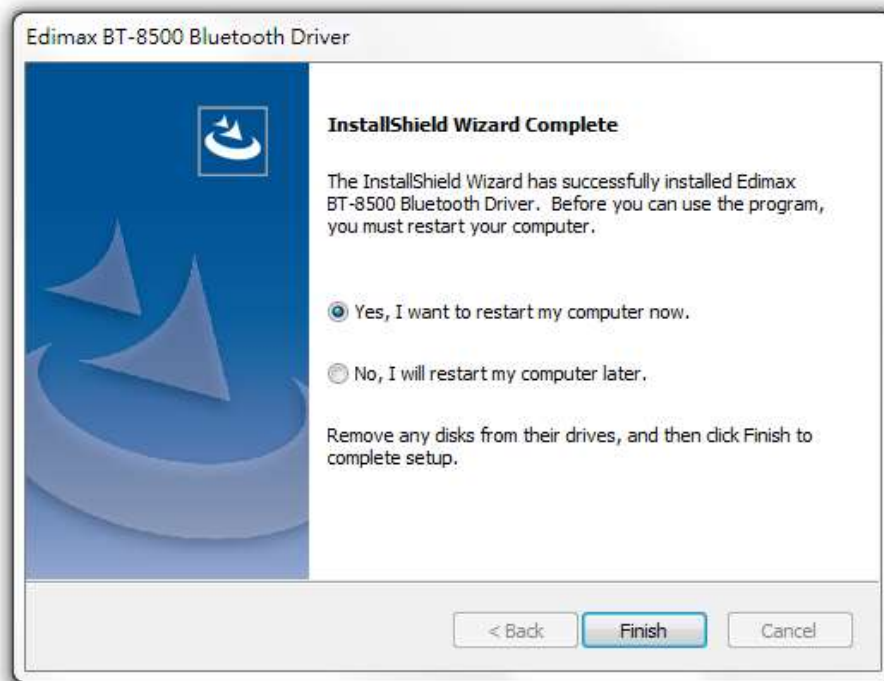

IV. Apparaten toevoegen

Volg alstublieft de volgende stappen om Bluetooth apparaten toe te voegen,

1. Ga naar Windows Bluetooth instellingen met gebruik van de zoekbalk, of door met uw rechtermuis op het Bluetooth-pictogram te klikken in de taakbalk en kies Een bluetooth apparaat toevoegen.

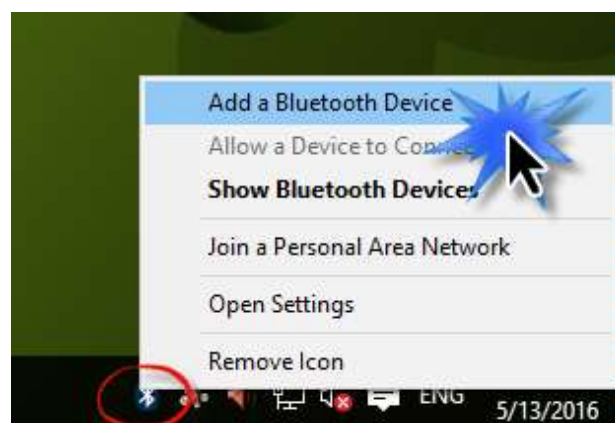

2. Selecteer uw Bluetooth apparaat en klik op 'Pair' en bevestig het wachtwoord.

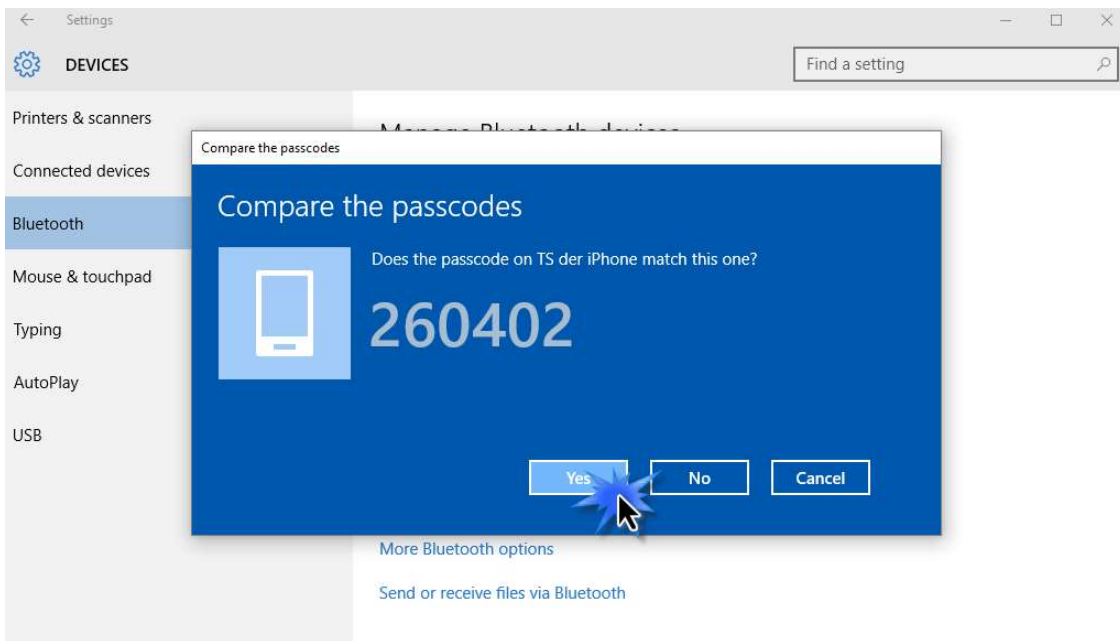
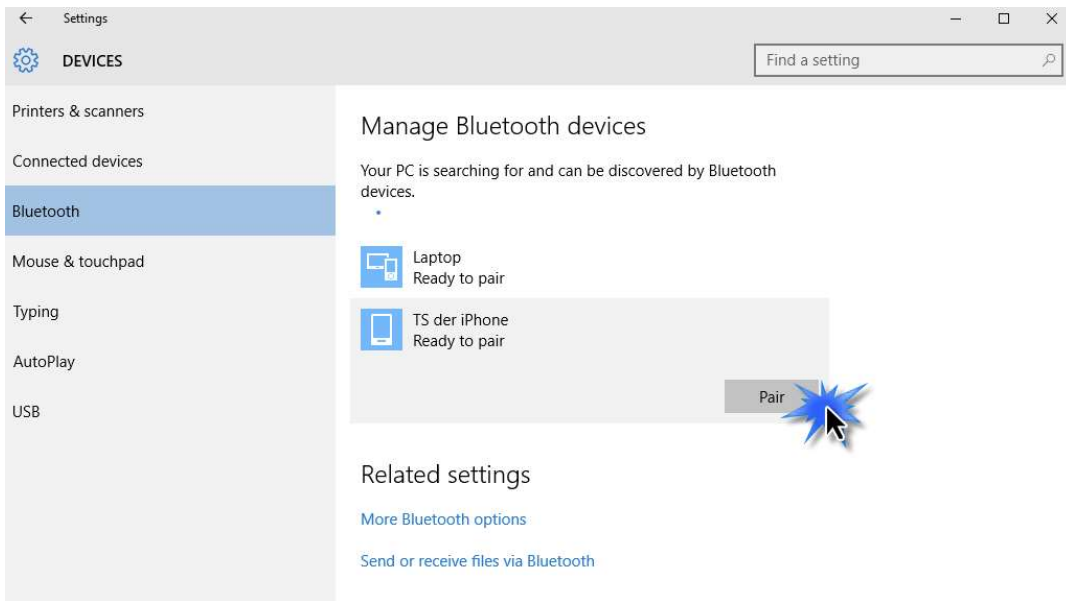

3. Uw apparaat is nu gereed voor gebruik als het weergeeft “Verbonden”.

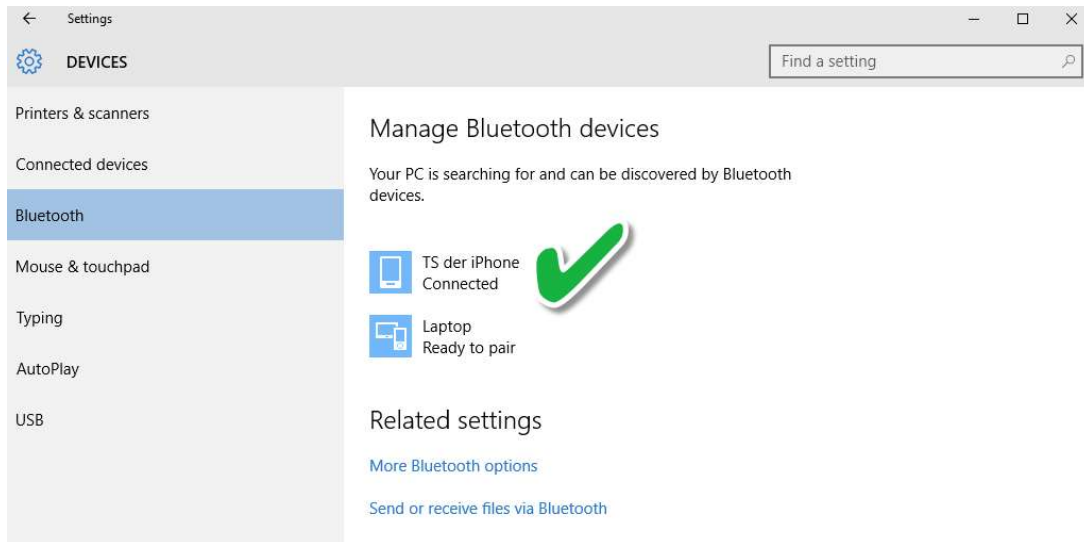

v.

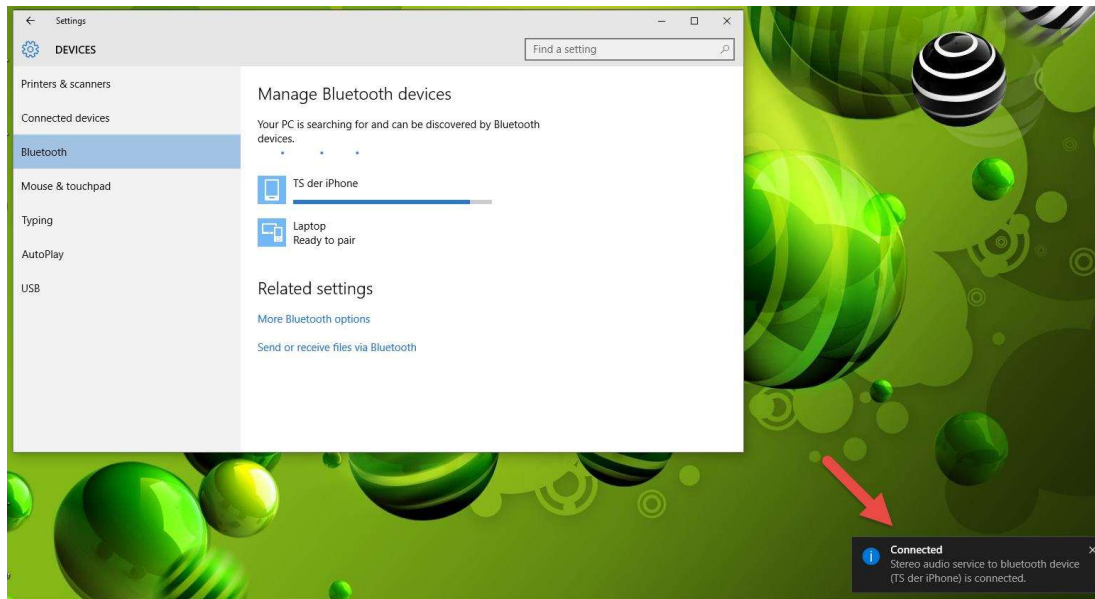

V. Een driver verwijderen

Volg de onderstaande instructies om de installatie van uw USB-adapter ongedaan te maken,

1. Open het configuratiescherm via het Startmenu of Zoekfunctie.

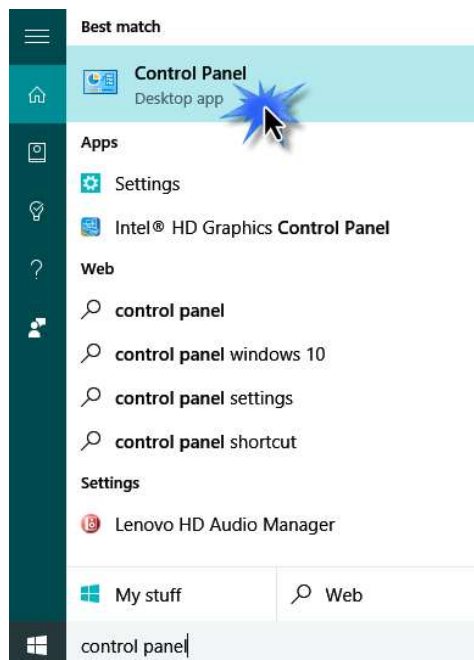

2. Selecteer een programma Verwijderen bij de Programma categorie.



3. Selecteer Edimax BT-8500 (of vergelijkbaar) en Edimax Bluetooth 5.0 (of vergelijkbaar) en klik op Uninstall.

Uninstall or change a program

To uninstall a program, select it from the list and then click Uninstall, Change or Repair.

Name	Publisher	Installed On	Size	Version
Edimax Wi-Fi N150 Bluetooth4.0 Wi-Fi USB Adapter D...	Edimax Technology Co.	10/05/2016	11.0 MB	1.00.0272
Edimax Bluetooth 4.0 USB Adapter Driver	Edimax Technology Co., Ltd	10/05/2016	16.6 MB	3.886.880.030916
Microsoft Visual C++ 2012 Redistributable (x64) - 11.0...	Microsoft Corporation	10/05/2016		11.0.51106.1
Microsoft Visual C++ 2008 Redistributable - x64 9.0.3...	Microsoft Corporation	08/05/2016	1.62 MB	9.0.30729.4148
Microsoft Visual C++ 2008 Redistributable - x86 9.0.3...	Microsoft Corporation	08/05/2016	6.55 MB	9.0.30729.4148
Opera Stable 37.0.2178.32	Opera Software	08/05/2016	258 MB	37.0.2178.32
Microsoft Office 365 Small Business Premium - en-us	Microsoft Corporation	08/05/2016	968 MB	16.0.6868.2060

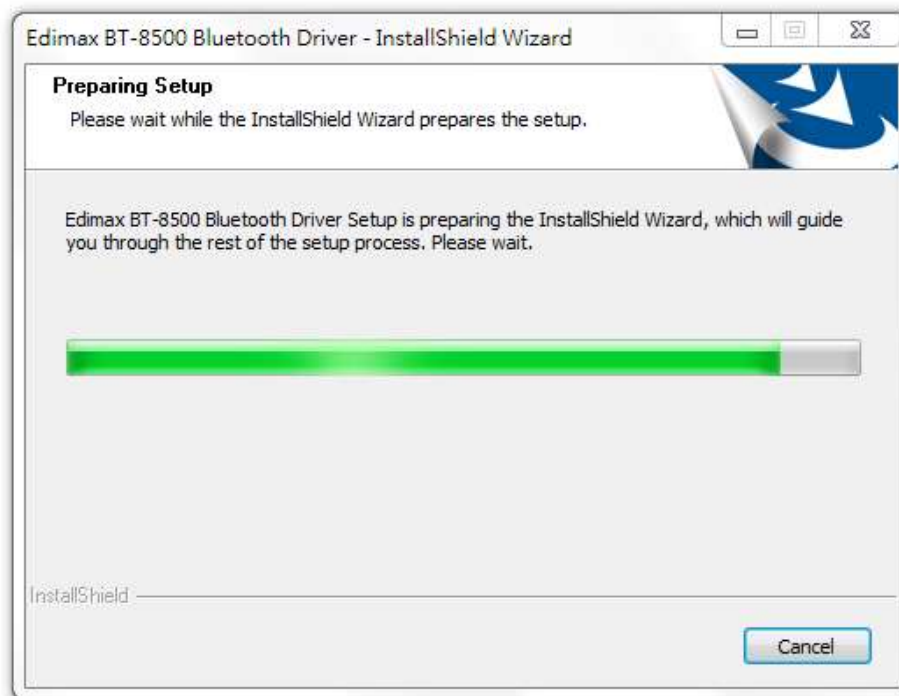

4. Klik op Ja om verder te gaan.



5. Kies of u uw computer nu of op een later moment wilt herstarten en klik op "Voltooien".

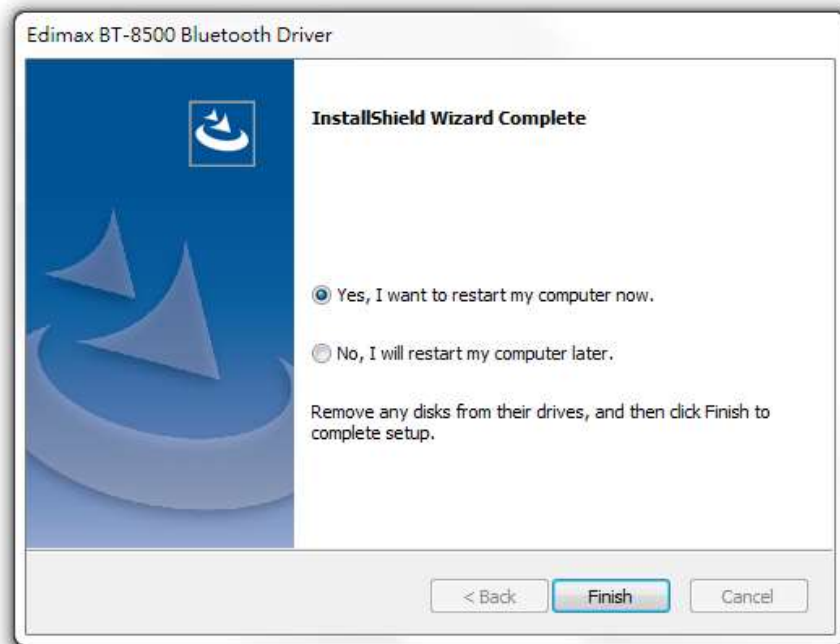

COPYRIGHT

Copyright © Edimax Technology Co., Ltd. all rights reserved. No part of this publication may be reproduced, transmitted, transcribed, stored in a retrieval system, or translated into any language or computer language, in any form or by any means, electronic, mechanical, magnetic, optical, chemical, manual or otherwise, without the prior written permission from Edimax Technology Co., Ltd.

Edimax Technology Co., Ltd. makes no representations or warranties, either expressed or implied, with respect to the contents hereof and specifically disclaims any warranties, merchantability, or fitness for any particular purpose. Any software described in this manual is sold or licensed as is. Should the programs prove defective following their purchase, the buyer (and not this company, its distributor, or its dealer) assumes the entire cost of all necessary servicing, repair, and any incidental or consequential damages resulting from any defect in the software. Edimax Technology Co., Ltd. reserves the right to revise this publication and to make changes from time to time in the contents hereof without the obligation to notify any person of such revision or changes.

The product you have purchased and the setup screen may appear slightly different from those shown in this QIG. The software and specifications are subject to change without notice. Please visit our website www.edimax.com for updates. All brand and product names mentioned in this manual are trademarks and/or registered trademarks of their respective holders.

Federal Communication Commission Interference Statement

This equipment has been tested and found to comply with the limits for a Class B digital device, pursuant to Part 15 of FCC Rules. These limits are designed to provide reasonable protection against harmful interference in a residential installation. This equipment generates, uses, and can radiate radio frequency energy and, if not installed and used in accordance with the instructions, may cause harmful interference to radio communications. However, there is no guarantee that interference will not occur in a particular installation. If this equipment does cause harmful interference to radio or television reception, which can be determined by turning the equipment off and on, the user is encouraged to try to correct the interference by one or more of the following measures:

1. Reorient or relocate the receiving antenna.
2. Increase the separation between the equipment and receiver.
3. Connect the equipment into an outlet on a circuit different from that to which the receiver is connected.
4. Consult the dealer or an experienced radio technician for help.

FCC Caution

This device and its antenna must not be co-located or operating in conjunction with any other antenna or transmitter. This device complies with Part 15 of the FCC Rules. Operation is subject to the following two conditions: (1) this device may not cause harmful interference, and (2) this device must accept any interference received, including interference that may cause undesired operation. Any changes or modifications not expressly approved by the party responsible for compliance could void the authority to operate equipment.

Federal Communications Commission (FCC) Radiation Exposure Statement

This equipment complies with FCC radiation exposure set forth for an uncontrolled environment.

Federal Communications Commission (FCC) RF Exposure Requirements

This equipment complies with FCC radiation exposure limits set forth for an uncontrolled environment. End user must follow the specific operating instructions for satisfying RF exposure compliance.

RED Compliance Statement

Compliance with 2014/53/EU Radio Equipment Directive (RED)

In accordance with Article 10.8(a) and 10.8(b) of the RED, the following table provides information on the frequency bands used and the maximum RF transmit power of the product for sale in the EU:

Frequency range (MHz)	Max. Transmit Power (dBm)
2412-2472	9.97

A simplified DoC shall be provided as follows: Article 10(9)

Hereby, Edimax Technology Co., Ltd. declares that the radio equipment type **Bluetooth 5.0 USB Adapter** is in compliance with Directive 2014/53/EU

The full text of the EU declaration of conformity is available at the following internet address: <http://www.edimax.com/edimax/global/>

Safety

This equipment is designed with the utmost care for the safety of those who install and use it. However, special attention must be paid to the dangers of electric shock and static electricity when working with electrical equipment. All guidelines of this and of the computer manufacture must therefore be allowed at all times to ensure the safe use of the equipment.

EU Countries Intended for Use

The ETSI version of this device is intended for home and office use in Austria, Belgium, Bulgaria, Cyprus, Czech, Denmark, Estonia, Finland, France, Germany, Greece, Hungary, Ireland, Italy, Latvia, Lithuania, Luxembourg, Malta, Netherlands, Poland, Portugal, Romania, Slovakia, Slovenia, Spain, Sweden, Turkey, and United Kingdom. The ETSI version of this device is also authorized for use in EFTA member states: Iceland, Liechtenstein, Norway, and Switzerland.

EU Countries Not Intended for Use

None

EU Declaration of Conformity

- English:** This equipment is in compliance with the essential requirements and other relevant provisions of Directive 2014/53/EU, 2014/35/EU.
- Français:** Cet équipement est conforme aux exigences essentielles et autres dispositions de la directive 2014/53/EU, 2014/35/EU.
- Čeština:** Toto zařízení je v souladu se základními požadavky a ostatními příslušnými ustanoveními směrníc 2014/53/EU, 2014/35/EU.
- Polски:** Urządzenie jest zgodne z ogólnymi wymaganiami oraz szczególnymi warunkami określonymi Dyrektywą UE 2014/53/EU, 2014/35/EU.
- Română:** Acest echipament este în conformitate cu cerințele esențiale și alte prevederi relevante ale Directivei 2014/53/UE, 2014/35/UE.
- Русский:** Это оборудование соответствует основным требованиям и положениям Директивы 2014/53/EU, 2014/35/EU.
- Magyar:** Ez a berendezés megfelel az alapvető követelményeknek és más vonatkozó irányelveknek (2014/53/EU, 2014/35/EU).
- Türkçe:** Bu cihaz 2014/53/EU, 2014/35/EU direktifleri zorunlu istekler ve diğer hükümlerle ile uyumludur.
- Українська:** Обладнання відповідає вимогам і умовам директиви 2014/53/EU, 2014/35/EU.
- Slovenčina:** Toto zariadenie spĺňa základné požiadavky a ďalšie príslušné ustanovenia smerníc 2014/53/EU, 2014/35/EU.
- Deutsch:** Dieses Gerät erfüllt die Voraussetzungen gemäß den Richtlinien 2014/53/EU, 2014/35/EU.
- Español:** El presente equipo cumple los requisitos esenciales de la Directiva 2014/53/EU, 2014/35/EU.
- Italiano:** Questo apparecchio è conforme ai requisiti essenziali e alle altre disposizioni applicabili della Direttiva 2014/53/EU, 2014/35/UE.
- Nederlands:** Dit apparaat voldoet aan de essentiële eisen en andere van toepassing zijnde bepalingen van richtlijn 2014/53/EU, 2014/35/EU.
- Português:** Este equipamento cumpre os requisitos essenciais da Directiva 2014/53/EU, 2014/35/EU.
- Norsk:** Dette utstyret er i samsvar med de viktigste kravene og andre relevante regler i Direktiv 2014/53/EU, 2014/35/EU.
- Svenska:** Denna utrustning är i överensstämmelse med de väsentliga kraven och övriga relevanta bestämmelser i direktiv 2014/53/EU, 2014/35/EU.
- Dansk:** Dette udstyr er i overensstemmelse med de væsentligste krav og andre relevante forordninger i direktiv 2014/53/EU, 2014/35/EU.
- suomen kieli:** Tämä laite täyttää direktiivien 2014/53/EU, 2014/35/EU. oleelliset vaatimukset ja muut asiaankuuluvat määräykset.

FOR USE IN 



WEEE Directive & Product Disposal



At the end of its serviceable life, this product should not be treated as household or general waste. It should be handed over to the applicable collection point for the recycling of electrical and electronic equipment, or returned to the supplier for disposal.

Declaration of Conformity

We, Edimax Technology Co., Ltd., declare under our sole responsibility, that the equipment described below complies with the requirements of the European Radio Equipment directives.

Equipment: Bluetooth 5.0 USB Adapter
Model No.: BT-8500

The following European standards for essential requirements have been followed:

Directives 2014/53/EU

Spectrum : EN 300 328 V2.2.2 (2019-07)
EMC : EN 301 489-1(Class B) V2.2.3 (2019-11)
EN 301 489-17 V3.2.2 (Draft) (2019-12)
EMF : EN 62479:2010
Safety (LVD) : IEC 62368-1:2014 (2nd Edition) and/or EN 62368-1:2014+A11:2017

Edimax Technology Europe B.V.	a company of :
Fijenhof 2,	Edimax Technology Co., Ltd.
5652 AE Eindhoven,	No. 278, Xinhua 1st Rd.,
The Netherlands	Neihu Dist., Taipei City,
	Taiwan

Signature:

Printed Name: David Huang
Title: Director
Edimax Technology Europe B.V.



Date of Signature: July, 2020

Signature:

Printed Name: Albert Chang

Title: Director

Edimax Technology Co., Ltd.